

CAUTION:

To clean use soft, dry cloth. Do not use detergent or chemicals
Avoid contact with water and direct sunlight.
To be assembled on a soft, dry, clean and smooth surface.

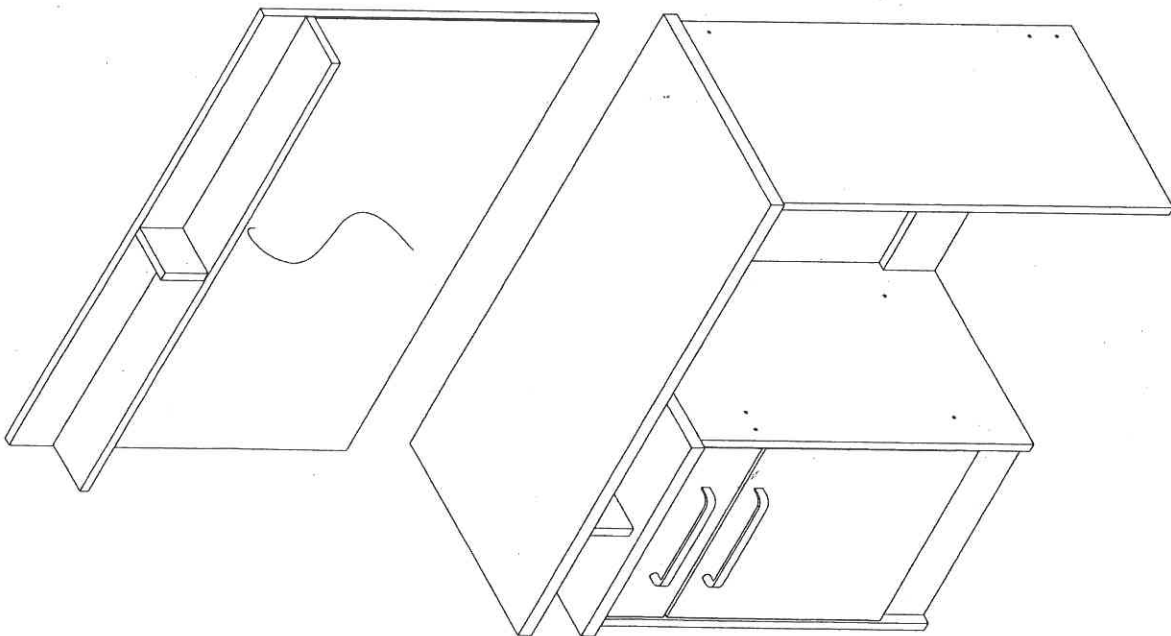

ORDERING REPAIR PARTS

In order to obtain smooth and rapid service when ordering repair parts, please give full attention to the following of **PART NUMBER**.

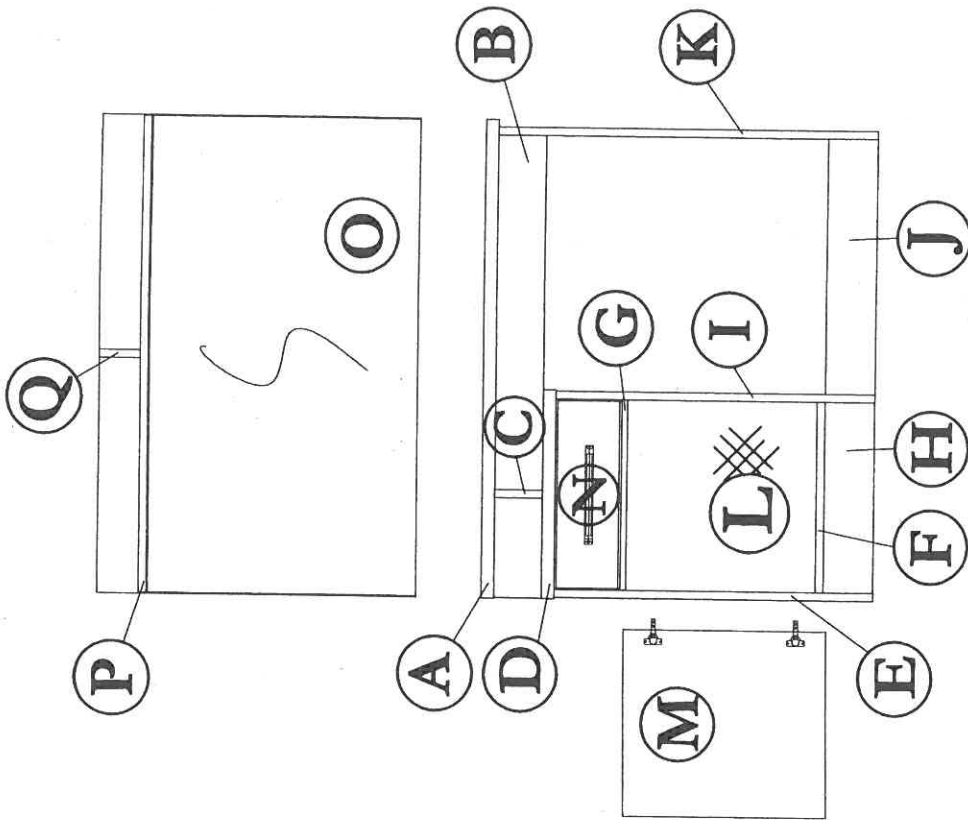

NO	DESCRIPTION	QTY
A	TOP	01
B	BACK SUPPORT	01
C	CENTRE VERTICAL	01
D	TOP	01
E	LEFT SIDE	01
F	LOWER SHELF	01
G	HORIZONTAL SHELF	01
H	LEG (Left side)	01
I	CENTRE VERTICAL	01

NO	DESCRIPTION	QTY
J	LEG (Right Side)	01
K	RIGHT SIDE	01
L	BACK	01
M	DOOR	01
N	DRAWER FACE	01
O	VERTICAL GLASS	01
P	CENTRE SHELF	01
Q	CENTRE VERTICAL	01

COMPLETE SET

ASSEMBLY INSTRUCTION

MODEL : 5576 / DRESSING TABLE

Before you begin, please follow assembly instruction carefully.
Then follow them step by step.

STEP 1

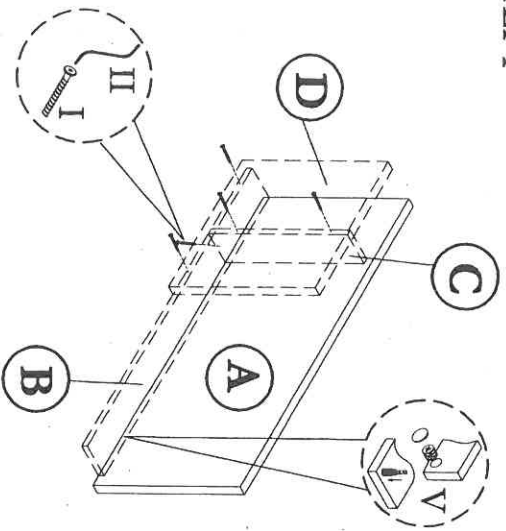

STEP 2

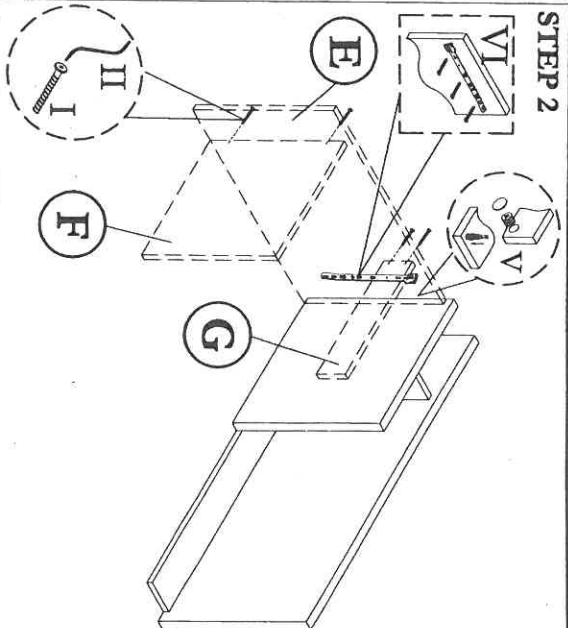

STEP 3

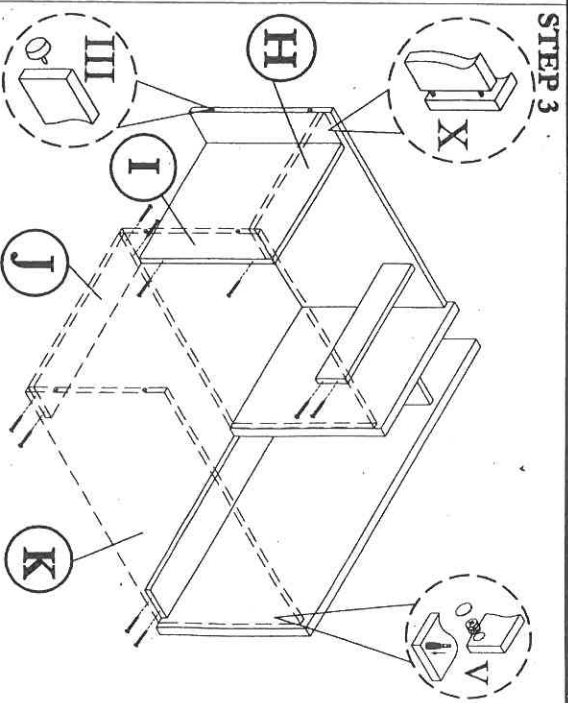

STEP 4

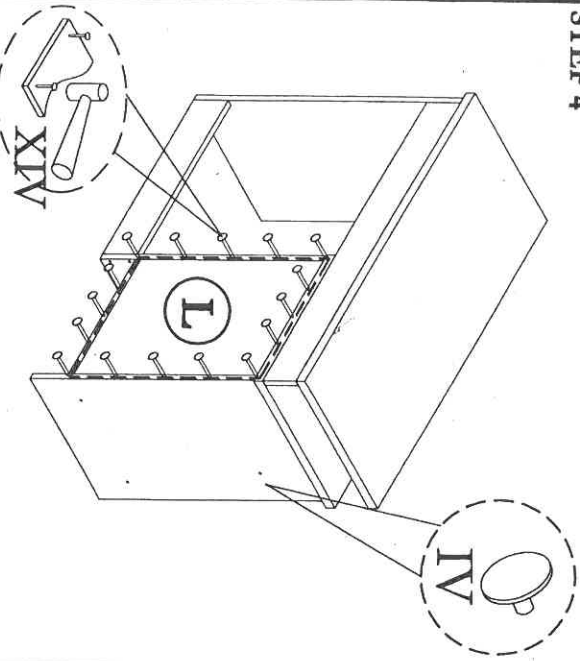

STEP 5

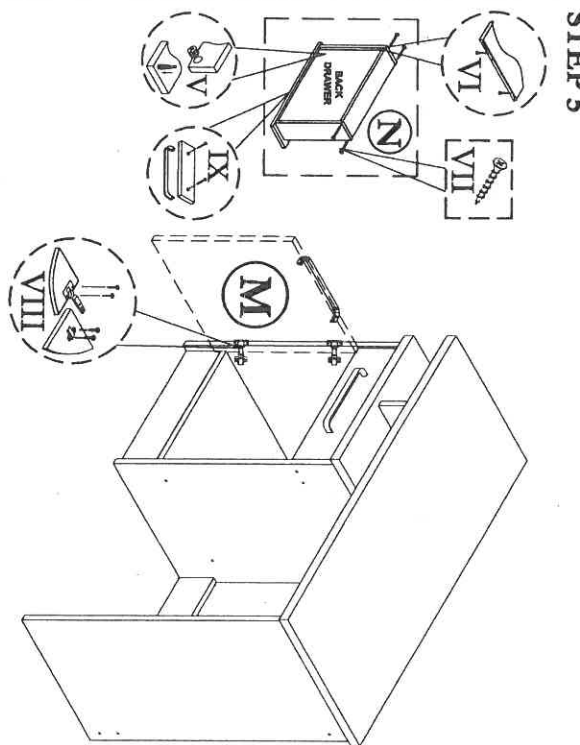

STEP 6

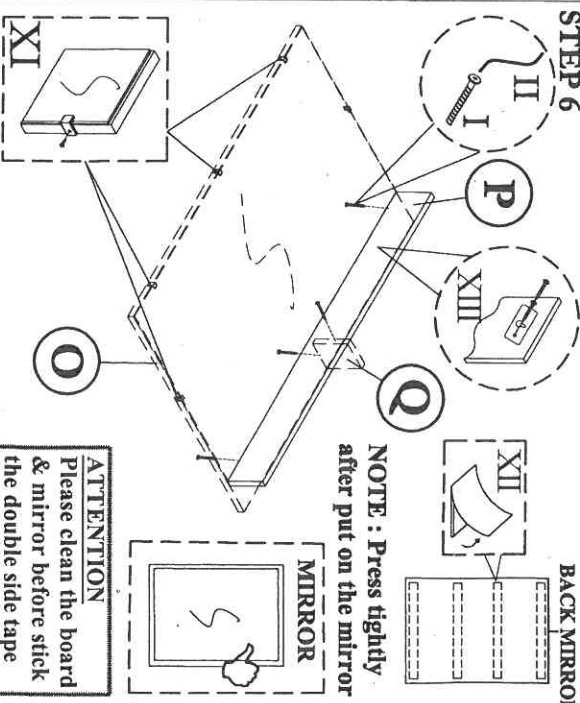

ATTENTION
Please clean the board & mirror before stick the double side tape

NOTE : Press tightly after put on the mirror

MIRROR

BACK MIRROR

HARDWARE LIST		
NO	DESCRIPTION	QTY
I	JCBCW SCREW M6 x 45	23pcs
II	M4 ALLEN KEY	1pc
III	PVC NAIL WITH PIN	6pcs
IV	CAP SMALL	12pcs

Q-FIT		
NO	DESCRIPTION	QTY
VI	DRAWER SLIDER & SCREW M3.5 x 12	11sets
VII	M8 x 32 CHIPBOARD SCREW	1sets
VIII	HINGE (C) & SCREW M3.5 x 16	4pcs
IX	HANDLE & SCREW M3.5 x 30	2sets
X	M8 x 30 PLASTIC DOWEL	2sets

XI	GLASS SUPPORT & SCREW M3.5 x 12	5sets
XII	DOUBLE SIDE TAPE	6pcs
XIII	WALL CABINET SUPPORT & SCREW M3.5 x 12	2sets
XIV	NAIL	20pcs